

HEATMASTER, LLC

AMERICAN GAS LOG

Installation Instructions

Models:

SBS-18,24,30NG

SBSIII-18,24,30NG

For use with Natural gas only.



Installation and service of this appliance should be performed by qualified personnel. Heatmaster/American Gas Log, LLC. suggests NFI certified or factory-trained professionals, or technicians supervised by an NFI certified professional.



Check with your local building code agency before you begin installation to ensure compliance with local codes, including the need for permits and follow-up inspections. If you encounter any problems regarding code approvals, or if you need clarification of any of the instructions contained here, contact the Technical Services Dept., Heatmaster/American Gas Log, LLC. 919-331-0078 or 919-331-0079.

CAUTION

DO NOT DISCARD THIS MANUAL



• Important operating and maintenance instructions included. Read, understand and follow these instructions for safe installation and operation.

INSTALLER: Leave this manual with the appliance.

Consumer: Retain this manual for future reference.



⚠ WARNING



If the information in these instructions is not followed exactly, a fire may result causing property damage, personal injury, or death.

- Do not store or use gasoline or other flammable vapors and liquids in the vicinity of this or any other appliance.
- **What to do if you smell gas:**
 - Do not try to light any appliance.
 - Do not touch any electrical switch. Do not use any phone in your building.
 - Immediately call your gas supplier from a neighbor's phone. Follow the gas supplier's instructions.
 - If you cannot reach your gas supplier, call the fire department.
- Installation and service must be performed by a qualified installer, service agency, or the gas supplier.

⚠ WARNING



**HOT! DO NOT TOUCH.
SEVERE BURNS MAY RESULT.
CLOTHING IGNITION MAY RESULT.**

Glass and other surfaces are hot during operation and cool down.

- Keep children away.
- **CAREFULLY SUPERVISE** children in same room as appliance.
- Alert children and adults to hazards of high temperatures.
- Keep clothing, furniture, draperies and other combustibles away.

In the Commonwealth of Massachusetts:

- This appliance must be installed by a licensed plumber or gas fitter.
- The chimney flue damper, when used with gas logs, will be welded open or completely removed.
- A CO detector shall be installed in the room where the appliance is installed.

**Read this manual before installing or operating this appliance.
Please retain this owner's manual for future reference.**

Congratulations

Congratulations on selecting a Heatmaster/American Gas Log, LLC. gas log set—an elegant and clean alternative to burning wood. The Heatmaster/American Gas Log, LLC. gas log set you have selected is designed to provide the utmost in safety, reliability, and efficiency.

As the owner of this new gas log set, you'll want to read and carefully follow all of the instructions contained in this owner's manual. Pay special attention to all cautions and warnings.

This owner's manual should be retained for future reference. We suggest you keep it with your other important documents and product manuals.

The information contained in this owner's manual, unless noted otherwise, applies to all models and gas control systems.

Your new gas log set will give you years of durable use and trouble-free enjoyment. Welcome to the Heatmaster/American Gas Log, LLC. family of appliance products!

Homeowner Reference Information

We recommend that you record the following pertinent information about your gas log set:

Model Name: _____ Date purchased/installed: _____

Serial Number: _____ Location on appliance: _____

Dealership purchased from: _____ Dealer phone: _____

Notes: _____

WARNING

Improper installation, adjustment, alteration, service or maintenance can cause injury or property damage. Refer to the owner's information manual provided with this appliance. For assistance or additional information consult a qualified installer, service agency or the gas supplier.

CAUTION



Sharp Edges
• Wear protective gloves and safety glasses during installation.



B. Tools and Supplies Needed

Tools and supplies normally required for installation:

- Pliers
- Phillips screwdriver
- Tape measure
- Crescent wrenches
- Gas shutoff valve
- Non-corrosive leak check solution
- 3/4 in. wrench, 7/16 in. wrench

C. Important!

- Do not remove any of the attached metal plates, which contain important safety and operating information.
- Keep the appliance area clear and free of all combustible materials, gasoline and other flammable vapors and liquids.
- Any safety screen or guard removed during servicing must be replaced before operation.
- **A qualified service technician must perform installation and repair.** The appliance should be inspected and cleaned annually by a qualified service technician. More frequent cleaning may be required due to excessive lint, dust, pet hair, etc. It is imperative that the control compartments, burners and air passageways are unobstructed during operation.

A. Design and Installation Considerations

The Gas Log Hearth Kit consists of the following:

- Log Set (sold separately)
- Burner/Pan Assembly/Hardware
- Grate Assembly
- Rock Wool
- Sand
- Lava Rock
- Damper Stop
- Vermiculite
- Platinum Embers

	WARNING
	HOT! DO NOT TOUCH. SEVERE BURNS MAY RESULT. CLOTHING IGNITION MAY RESULT.
	Glass and other surfaces are hot during operation and cool down.
<ul style="list-style-type: none"> • Keep children away. • CAREFULLY SUPERVISE children in same room as appliance. • Alert children and adults to hazards of high temperatures. • Keep clothing, furniture, draperies and other combustibles away. 	

- This appliance must have a screen in place while the appliance is in operation and, unless other provisions for combustion air are provided, the screen shall have an opening for introduction of combustion air.
- Solid fuels shall not be burned in a fireplace where a decorative appliance is installed.
- If glass doors are present, the **glass doors must be fully opened** while appliance is in operation.

	WARNING
Do NOT use this appliance if any part has been under water. Immediately call a qualified service technician to inspect the appliance and to replace any part of the control system and any gas control which has been under water.	

D. Appliance Certification

This appliance has been evaluated by PFS in accordance with the requirements of Ansi Z21.84-2017 *Standard for Decorative Log Sets for Installation in Wood Burning Fireplaces*. Installation and the provisions for combustion and ventilation air must conform to the **National Fuel Gas Code, ANSI Z223.1/NFPA 54**, or the **CSA B149.1, Natural Gas and Propane Installation Code**.

E. Gas Supply Connection



A 3/8 in. flared fitting has been installed on the gas valve inlet at the factory. Ensure fittings are of the appropriate size and type on the gas line connection. If the tubing has to be cut to length be sure to use the proper cutting and flaring tool. Also, be careful not to crimp the tubing while bending. If the tubing becomes crimped, do not use for installation.

Gas resistant pipe compound must be used on all threaded male connections to ensure a tight seal.



F. Gas Pressure



Proper input pressures are required for optimum appliance performance. Gas line sizing requirements need to be made following **NFPA51**.

- Review proper placement of logs, rockwool, lava rock and vermiculite.
- Check the wiring.
- Ensure there are no gas leaks.
- Ensure the flow of combustion and ventilation air is not obstructed (front grilles and vent caps).
- Before installing into a solid fuel burning fireplace, the chimney and firebox should be inspected and cleaned to remove soot, creosote, ashes, paint, bird nests etc.
- Annual examination of the chimney must be performed by a qualified agency to ensure proper ventilation of flue gases created by this appliance.

	WARNING
	Fire Risk Exhaust Fumes Risk
	<ul style="list-style-type: none"> • Do NOT use this appliance as an unvented heater. <p>The flue must be permanently open according to Tables 1 and 2.</p>

- Have the chimney and adjacent structure inspected and cleaned by qualified professionals. Heatmaster/American Gas Log, LLC. recommends that NFI or CSIA certified professionals, or technicians under the direction of certified professionals, conduct a minimum of an **NFPA 211 Level 2** inspection of the chimney.
- Replace component parts of the chimney and fireplace as specified by the professionals.
- Ensure all joints are properly engaged and the chimney is properly secured.
- Do not allow fans to blow directly into the fireplace. Avoid any drafts that alter burner flame pattern.
- Do not use a blower insert, heat exchanger insert or other accessories not approved for use with this appliance.

	WARNING
	Fire Risk Explosion Risk
	<p>High pressure will damage valve.</p> <ul style="list-style-type: none"> • Disconnect gas supply piping BEFORE pressure testing gas line at test pressures above 1/2 psig. • Close the manual shutoff valve BEFORE pressure testing gas line at test pressures equal to or less than 1/2 psig.

	WARNING
	Fire Risk
	Explosion Risk
	Verify inlet pressures.
	<ul style="list-style-type: none"> • High pressure may cause over fire condition. • Low pressure may cause explosion.
	Install regulator upstream of valve if line pressure is greater than 1/2 psig.

G. Negative Pressure

Negative pressure results from the imbalance of air available for the fireplace to operate properly. Causes for this imbalance include:

- Exhaust fans (kitchen, bath, etc.).
- Range hoods.
- Combustion air requirements for furnaces, water heaters and other combustion appliances.
- Clothes dryers.
- Location of return-air vents to furnace or air conditioning.
- Imbalances of the HVAC air handling system.
- Upper level air leaks: recessed lighting, attic hatch opening, duct leaks.

- Gas Supply Pressure: Minimum inlet gas supply pressure must be 7.0 in. W.C. for natural gas. The gas line supplying the appliance must be sufficient size to furnish the appropriate supply pressure to the appliance while operating in the “High” setting.
- Pressure tap screws must be closed before turning gas on to the appliance.
- Gas Line Pressure Test: Perform pressure test according to state and local code (if pressure exceeds 1/2 in. psi (3.5 kPa)) before appliance is connected. Be sure to release air pressure from the gas line before connection is made to the appliance. Excessive pressure will damage the gas control and may cause a gas leak.
- Gas Leak Test: Make sure the gas connections are tight. Turn on the gas and coat each joint with a non-corrosive gas leak check solution. Air bubbles will form indicating any leaks. DO NOT USE A FLAME OR ANY TYPE OF IGNITION SOURCE TO CHECK FOR LEAKS. All leaks must be corrected before proceeding with installation.
- The appliance must only be installed in a solid-fuel burning fireplace with the flue damper clamped open according to Tables 1 and 2. The fireplace must be constructed of non-combustible material.
- The minimum permanent free opening (in square inches) that must be provided by the fireplace chimney or damper to vent the flue gases is provided in Tables 1 and 2. If the free opening is smaller than the specified area, do not use this appliance.
- The damper must be removed or fixed in a manner in which will secure it open. Some jurisdictions require the damper to be removed or permanently welded fully open. Check with state and local codes.
- Be sure that the chimney is completely unobstructed to ensure proper ventilation of flue gases including carbon monoxide (CO). CO (a poisonous gas) is tasteless, odorless, colorless and undetectable without proper equipment.
- Refer to Table 3 to determine minimum fireplace opening requirements before proceeding.



	WARNING
	Asphyxiation Risk
	This appliance produces carbon monoxide (CO).
	<ul style="list-style-type: none"> • The free opening areas (in square inches) of the chimney damper as shown in the following tables must be met. • User must make sure damper is locked open. • The installer is responsible to ensure proper ventilation of flue gases before appliance is used.
	Fire needs to draft properly for safe operation.

Table 1 for Factory Built Fireplaces

Free Opening Area (in square inches) of Chimney Damper for Venting combustion Products from Decorative Appliances for Installation in Solid Fuel Burning Fireplaces.

Chimney Ht. (Feet)*	18 in. Log Set Natural Gas	24 in. Log Set Natural Gas	30 in. Log Set Natural Gas
10	28.3	not approved	not approved
15	21.2	38.5	45.4
20	18.1	31.2	37.4
25	15.9	27.3	31.2
30	14.5	24.6	28.3
35	13.2	22.1	25.5
40	12.6	20.4	23.8

Table 2 for Masonry Built Fireplaces

Free Opening Area (in square inches) of Chimney Damper for Venting combustion Products from Decorative Appliances for Installation in Solid Fuel Burning Fireplaces.

Chimney Ht. (Feet)*	18 in. Log Set Natural Gas	24 in. Log Set Natural Gas	30 in. Log Set Natural Gas
6	41.7	64	71.4
8	38.7	59.7	66.9
10	35.2	54.3	60.2
15	32.0	48.8	54.1
20	28.8	44.4	49.1
30	26.5	40.3	44.5

* Height is measured from the hearth to the top of the chimney.
Minimum height is 6 ft.

Table 3 for Minimum Fireplace Dimensions

Log Set	Front Opening	Depth	Height	Rear Width	Natural BTU
SBS18	27 in	16 in	18 in	19 in	40,000
SBS24	34 in.	20 in.	18 in.	22 in.	73,000
SBS30	40 in.	20 in.	18 in.	29 in.	80,000
SBSIII18	32 in.	23 in	22 in.	21 in.	86,000
SBSIII24	34 in.	23 in.	22 in.	22 in.	86,000
SBSIII30	40 in.	23 in	22 in.	29 in.	86,000

H. Inspect the Appliance and Components

- Remove the contents from burner box. Attached to the burner are tags identifying the manufacturer name, serial number, model number (including gas log size), BTU ratings, gas type, etc.
- Review the attached tags before proceeding. Ensure that all minimum fireplace dimension requirements are achieved using Table 3. Ensure the gas type provided in the fireplace coincide with the gas type marked on the tag.

- The burner is assembled with the controls installed at the factory and is designed to connect one end of the 3/8 in. supply line before placing inside the fireplace. Ensure the connection is tightened using a 3/4 in. wrench.
- Place the burner towards the rear and center of the fireplace and connect to the gas line. Follow instructions in "F. Gas Pressure" to check for gas leaks.



Figure 1 Measure Firebox

I. For Natural Gas Installation

- Pour sand into the burner pans to the point where the burner pipe is covered. See Figure 3. Level the sand from right to left to ensure an even flame pattern. At this point the pan should be half full.

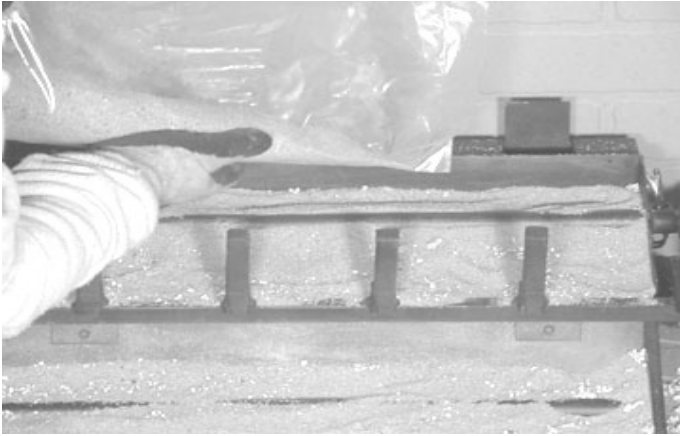

Figure 3 Sand



Figure 4 Placing Vermiculite

.Pour vermiculite over the sand in the pans until they are full. See Figure 4.

Note: For best results, do not pack down the rock wool. The placement of rock wool can have an effect on flame pattern and may need to be adjusted to achieve a desired appearance.

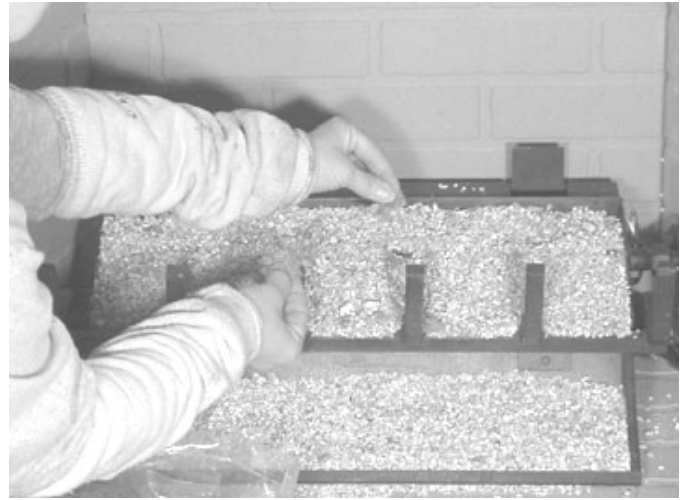

Figure 5 Placing Rock Wool

- Remove the Platinum Bright Embers™ from the package. For optimum performance peel each piece apart in layers and lightly place on top of the vermiculite and rock wool where the flame is blue. This will achieve the desired realism.
- The gas burns at the point of the least resistance. In case of an uneven flame pattern it may be necessary to adjust the materials in the pans (using an object such as a screwdriver) to achieve the desired effect.
- Place desired amount of lava granules on the floor of the fireplace. **DO NOT ALLOW THE GRANULES TO COME IN CONTACT WITH THE FLAMES.** (Lava granules may contain moisture which, when heating, may cause it to pop out during installation and set-up.) Ensure the controls and switches are unobstructed after the granules are installed.



⚠ WARNING



Fire Risk
Explosion Risk
Personal Injury Risk



Failure to position the parts in accordance with the diagrams provided with the log packages or failure to use only parts approved with this appliance may result in property damage or personal injury.

Note: Log placement photos and instructions are located in the log packages.

J. Damper Stop Installation Instructions

Included in the burner assembly box is a damper stop clamp which attaches to the damper as shown below. Install the clamp to the damper ensuring that the minimum requirements (Tables 1 and 2) are achieved. Use a 7/16 in. wrench to secure the clamp to the damper. If the damper clamp provided does not fit your application, other means of securing the proper opening must be provided by the installer.

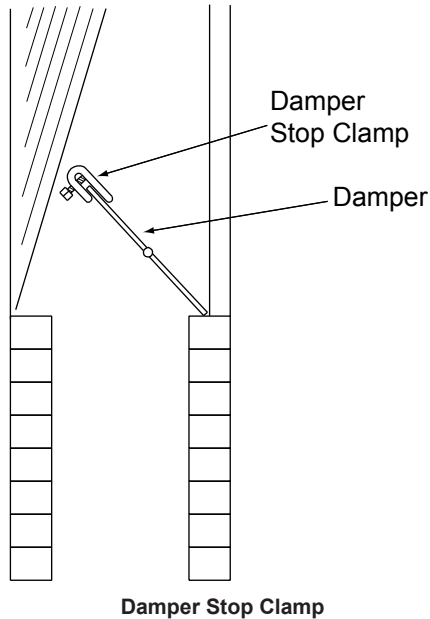

Note: The state of Massachusetts requires that the chimney flue damper, when used with gas logs, be welded open or completely removed. In the Commonwealth of Massachusetts this appliance must be installed by a licensed plumber or gas fitter.

K. Inspect the Venting System

The fireplace venting system is designed and constructed to develop a positive flow adequate to remove flue gases to the outside atmosphere. See fireplace installation instructions.

A spillage test must be made before the installed appliance is left with the consumer.

- Close all doors and windows in the home.
- Light the log set (see Lighting Instructions).
- After three minutes, test with a smoke match, smoke candle, stick incense or cigarette 1 in. below the top of the opening (lintel) moving across the full width. If spillage (smoke down into the room) occurs, it will most likely be near the top, outside corners.

Possible cures if spilling occurs:

- The damper needs to be opened further.
- The fireplace opening needs to be reduced by adding a drop panel across the top under the lintel.
- The air supply from outdoors needs to be increased. Open the outside air kit if the appliance is so equipped, or crack open a door or window.
- If necessary, seek expert advice. Do not operate this appliance.

M. Cleaning and Maintenance Instructions

Always remember:

- Do not place any combustible material near the appliance.
- Do not place any paper, trash or other material on the log set or in the heater.
- Do not touch any part of the appliance when it is in operation.
- Do not operate this appliance without the fireplace screen closed.

CAUTION

Before cleaning the appliance, be sure it is turned completely off. The appliance must be completely cooled.

CAUTION

- Logs can get very hot. Handle only when they are cool.

Your appliance is designed to be virtually maintenance free, although periodic visual inspection and cleaning is required. Follow the instructions below for the correct procedures. An annual examination and cleaning the venting system by a qualified person is also recommended.

If at any time the flames on your log set look abnormal or an odor is noticed coming from the appliance, contact a qualified service technician or the gas company.

Inspect the main burner.

CAUTION

After burning, the logs become fragile. Take care in handling.

Do not allow soot to build up on the logs

Your logs require little care. Keep the burner assembly, logs and burner area surrounding the logs clean by brushing with a dry paint brush at least twice a year.

- Always turn off the gas before cleaning. For relighting, refer to Section L. Lighting Instructions.
- Always keep the appliance clean and free from combustible materials, gasoline and other flammable vapors and liquids.
- Never obstruct the flow of combustion and ventilation air. Keep the front of the appliance clear of all obstacles and materials.
- Leave clearance of at least 36 in. from the front of the fireplace.
- The air shutter should not be blocked.

L. Lighting Instructions-Match Light

⚠ WARNING	
	Asphyxiation Risk Gas-burning appliances produce smoke and carbon monoxide gas during operation. <ul style="list-style-type: none">• The damper must be open• The chimney must draw properly These fumes can be harmful if not vented properly.

FOR YOUR SAFETY READ BEFORE LIGHTING

WARNING! IF THESE INSTRUCTIONS ARE NOT FOLLOWED EXACTLY, A FIRE OR EXPLOSION MAY RESULT CAUSING PROPERTY DAMAGE, PERSONAL INJURY OR LOSS OF LIFE.

- A. This appliance has a manually lighted burner and must be lit by hand. When lighting the burner, follow these instructions exactly.
- B. **BEFORE LIGHTING** smell all around the appliance area for gas. Be sure to smell next to the floor because some gas is heavier than air and will settle on the floor.
WHAT TO DO IF YOU SMELL GAS
 - Do not try to light any appliance.
 - Do not touch any electrical switch; do not use any phone in your building.
 - Immediately call your gas supplier from a neighbor's phone. Follow the gas supplier's instructions.
 - If you cannot reach your gas supplier, call the fire department.
- C. Do not use this appliance if any part has been under water. Immediately call a qualified service technician to inspect the appliance and to replace any part of the control system and any gas control that has been under water.
- D. Use only your hand to push in or turn the gas control handle. Never use tools. If the handle will not push in or turn by hand, do not try to repair it. Call a qualified service technician. Force or attempted repair may result in fire or explosion.

LIGHTING INSTRUCTIONS

1. **STOP!** Read the safety information previously listed above.
2. Turn gas control manual valve to the full "OFF" position.
3. Wait 5 minutes to clear out any gas. Then smell for gas, including near the floor. If you smell gas, STOP! Follow "B" in the safety information above on this label. If you don't smell gas, go to the next step.
4. Place a lit match on the surface of the burning embers. Do not hold match in hand.
5. Turn gas control manual valve to the full "ON" position.
6. If appliance will not operate, follow the instructions "TO TURN OFF GAS TO APPLIANCE" and call your service technician or gas supplier.

TO TURN OFF GAS TO APPLIANCE

Turn manual gas control handle to "OFF" position. Do not force.

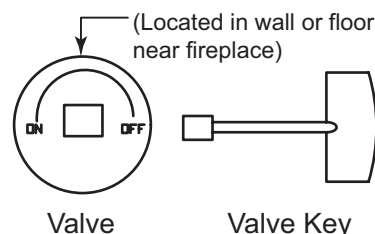
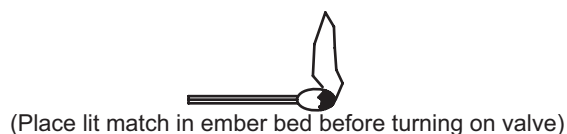

N. Frequently Asked Questions

Can I close the glass doors on my fireplace when using my gas logs?

No. The gas log sets are designed for use in fireplaces with all fireplace doors fully opened. Operating your log set with the doors closed will cause overheating, premature failure of valve systems, and will void the warranty of your log set.

What sort of maintenance do gas logs require?

Vented gas logs do not require regular maintenance. However, it is a good idea to have valves, pilots and gas connections on your set periodically inspected by a hearth professional. Although it is not required maintenance, annually refurbishing the ember material and periodic cleaning of the logs will help maintain your set's beauty and realism.

Does the ember material burn-up, and do I need to replace it periodically?

The ember material is a fireproof, organic mineral material called rock wool, and does not burn or require periodic replacement; however, annual refurbishment of the embers will help maintain the beauty and realism of your log set.

Can I burn real wood along with my gas logs?

No. The intense heat of a wood fire will damage your logs, burners, grates and valves, and will void your warranty.

Will gas logs help my chimney that drafts poorly?

No. Improper or poor draft will not be helped by gas logs. Please have your chimney inspected by a hearth professional or chimney sweep in order to determine how to correct the problem.

Can I close my fireplace damper to get more heat from my vented gas log set?

No. Vented gas logs are designed to be operated with the damper in the fully opened position. This gas log set produces carbon monoxide gas. The damper must be removed or clamped fully open using the "C" clamp provided with the set.

My gas logs make a whistling noise when I burn them. What causes this?

This behavior is normally caused by using a corrugated flex connector to hook up the gas log set. We recommend the installer use the supplied aluminum connector rather than the corrugated flexible type.

Can I move or change the position of the logs on my gas log set?

PFS certified log sets should not be altered - log placement must be exactly as indicated in the set's installation instructions.

Can I install my gas log set myself?

No. We recommend installation be performed by an NFI certified hearth professional, HVAC professional, gas fitter, or plumber experienced in gas log installation. Most localities require installation of any gas appliance to be performed by a professional. Please check with your local inspection agency/department.

What are the gas logs made of?

The gas logs are made of a mixture of pre-fired, expanded clay and a special high-temperature cement, with a wire mesh reinforcement. This combination creates a strong, ceramic material capable of withstanding extreme temperatures, yet also allows molding of the intricate detail found in these gas log sets.

I have a vented log set, and the logs have black soot on them. Is this normal?

Soot build-up on vented gas logs is a normal part of the combustion process. Natural gas log sets generally produce less soot than liquid propane log sets. We recommend any soot build up be removed periodically using a product designed for gas log soot removal.

Can I add a remote control to my log set after it has been installed?

No.

SBS- 18,24 & 30

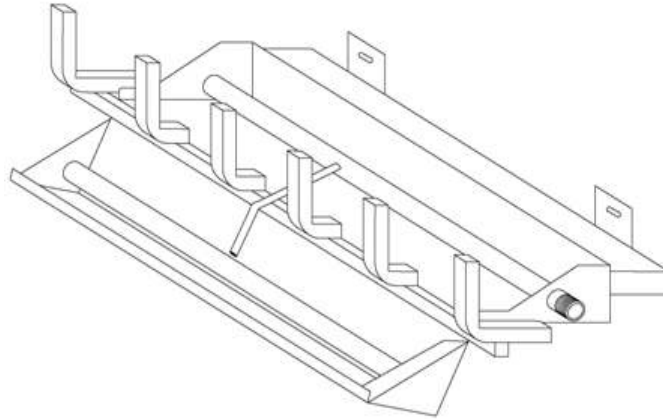

SBSIII-18,24 & 30

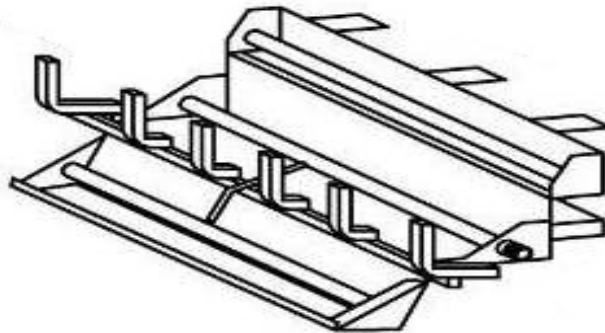

#	Description of Part	18in.	24 in.	30 in.	Qty.
	Burner Pan/Grate Assembly	BPA-300-18	BPA-300-24	BPA-300-30	1
	Burner Pan/Grate Assembly (3 Tier Only)	BPA-300-33	BPA-300-35	BPA-300-40	1
	Gas Line Connector	FT-1-18	FT-1-24	FT-1-30	1
	Bottom Burner Orifice NG	BPO-2-49	BPO-2-40	BPO-2-38	1
	Top Burner Orifice NG	BPO-2-36	BPO-2-26	BPO-2-26	1
	Top Burner Orifice NG (SBSIII)	BPO-2-40	BPO-2-49	BPO-2-49	1
	Middle Burner Orifice NG (SBSIII)	BPO-2-36	BPO-2-32	BPO-2-28	1
	Bottom Burner Orifice NG (SBSIII)	BPO-2-46	BPO-2-50	BPO-2-50	1
	Installation Manual	16-1012ML	16-1012ML	16-1012ML	

DECORATIVE GAS LOG LIMITED WARRANTY

Heatmaster/American Gas Log, LLC. extends the following warranty for decorative gas log sets as described herein, while it is in its location of original installation. Dealers and employees of Heatmaster/American Gas Log, LLC. have no authority to make any warranty or authorize any remedies in addition to or inconsistent with the terms of this Program. This warranty gives you specific legal rights. You may also have other rights which vary from state to state.

LIMITED WARRANTY. All refractory cement logs manufactured by Heatmaster/American Gas Log, LLC. have a lifetime warranty against breakage due to heat to the original owner in the original installation. All metal parts, including burners and grate assemblies are warranted for 5 years. All mechanical parts are warranted for 1 year. All refractory cement logs manufactured by Heatmaster/American Gas Log, LLC., have a lifetime warranty against breakage due to heat to the original owner in the original installation. All metal parts, including burners and grate assemblies are warranted for 5 years. All mechanical parts are warranted for 1 year. This Limited Warranty extends only to decorative gas log sets installed in the United States or Canada.

EXCLUSIONS AND QUALIFICATIONS. This Limited Warranty is subject to the following exclusions and qualifications: (1) This Limited Warranty does not apply to, and Heatmaster/American Gas Log, LLC., assumes no responsibility for, any damages that result due to the installation or operation of this decorative gas log set not in accordance with both the installation instructions and operating instructions furnished. (2) The decorative gas log set must be subjected to normal use as explained in the operating instructions and the listing agency identification label attached to the burner pan assembly. This decorative gas log set is only intended to burn the fuel specified on the listing agency identification label. Use of any other fuel other than specified on the listing agency identification label can create a life threatening situation and will void this limited warranty. (3) This Limited Warranty applies only if the decorative gas log system has been installed in a vented fireplace that is suitable for burning wood. Adequate ventilation must be provided to allow proper drafting of the fireplace chimney system. Heatmaster/American Gas Log, LLC., assumes no responsibility for improper performance of the decorative gas log set caused by inadequate draft due to environmental conditions (e.g. wind currents, downdrafts), tight-sealing construction of the structure, or mechanical devices (e.g. air handling devices that include forced air furnaces and air conditioning units, exhaust fans and ventilating devices), any and all of which may cause a negative pressure within the structure where the decorative gas log set is installed. (4) This Limited Warranty applies only to the components of the Appliance manufactured by Heatmaster/American Gas Log, LLC. Heatmaster/American Gas Log, LLC expressly excludes from this Limited Warranty any liability hereunder for defects or damage caused by the installation or use of any parts, devices or components that are not manufactured by Heatmaster/American Gas Log, LLC. (5) As part of this limited warranty no Labor costs will be paid by Heatmaster/American Gas Log, LLC. (6) This Limited Warranty will be voided if the decorative gas log set is at any time removed or has been removed from the location in which it was originally installed. (7) Since building code requirements vary greatly throughout the United States and Canada, users of this decorative gas log set should determine in advance whether there are any building code restrictions on the installation and use of this product. Heatmaster/American Gas Log, LLC makes no representation or warranty regarding building code compliance and shall not be responsible for compliance therewith.

THERE ARE NO IMPLIED WARRANTIES OF MERCHANTABILITY OR FITNESS FOR PARTICULAR PURPOSE LIMITATION OF LIABILITY. IT IS EXPRESSLY AGREED AND UNDERSTOOD THAT HEATMASTER/AMERICAN GAS LOG, LLC., OBLIGATION AND PURCHASERS EXCLUSIVE REMEDY UNDER THIS LIMITED WARRANTY, UNDER ANY OTHER WARRANTY, EXPRESSED OR IMPLIED (INCLUDING MERCHANTABILITY AND FITNESS FOR PARTICULAR PURPOSE), OR OTHERWISE, SHALL BE LIMITED TO THE REPLACEMENT OR REPAIR OF ONLY HM/AGL BRAND COMPONENTS AND OPTIONAL COMPONENTS AS SPECIFIED ABOVE. THE DURATION OF ANY IMPLIED WARRANTY INCLUDING MERCHANTABILITY AND FITNESS FOR PARTICULAR PURPOSE APPLICABLE TO THIS GAS APPLIANCE IS LIMITED TO THE DURATION OF THE FOREGOING WARRANTY. SOME STATES DO NOT ALLOW LIMITATIONS ON HOW LONG AN IMPLIED WARRANTY LASTS SO THE ABOVE WARRANTY MAY NOT APPLY TO YOU. IN NO EVENT SHALL HM/AGL BE RESPONSIBLE FOR ANY INCIDENTAL OR CONSEQUENTIAL DAMAGES CAUSED BY DEFECTS IN THE DECORATIVE GAS LOG SET, WHETHER SUCH DAMAGE OCCURS OR IS DISCOVERED BEFORE OR AFTER REPLACEMENT OR REPAIR, AND WHETHER SUCH DAMAGE IS CAUSED BY HM/AGL NEGLIGENCE. SOME STATES DO NOT ALLOW THE EXCLUSION OR LIMITATION OF INCIDENTAL OR CONSEQUENTIAL DAMAGES, SO THE ABOVE LIMITATION OR EXCLUSION MAY NOT APPLY TO YOU.

HOW TO OBTAIN SERVICE. To obtain service under this Program, you must:

1. Send written notice of the claimed condition to the Technical Service Department, Heatmaster/American Gas Log, LLC. 3625 Benson Rd, Angier, NC 27501.
2. Provide proof of purchase to Heatmaster/American Gas Log, LLC.
3. Provide Heatmaster/American Gas Log, LLC reasonable opportunity to investigate the claim, including reasonable opportunity to inspect the Fireplace prior to any repair or replacement work and before the Fireplace has been removed from the place of original installation.
4. Obtain Heatmaster/American Gas Log, LLC consent to any warranty work before the work is done.